

Date

January 18, 2021

Under Development

X-band GaN 40W/60W BUC

RF Frequency: 7.9 to 8.4 GHz

(40W model) Model No. NJT5873 series

(60W model) Model No. NJT5874 series

LO Frequency: 6.95 GHz
IF Frequency: 950 to 1,450 MHz
Saturated Output Power:
+46.0 dBm (40W) / +47.8 dBm (60W)
RF Input Interface: N-type, Female Connector
Power Requirement: DC +36-60V, MS Connector Input
/ AC 100-240V, MS Connector Input
M&C Option: Parallel I/O Interface
RS-422/485 Interface (OpenBMIP Protocol)
Ethernet Interface (OpenBMIP Protocol)

Copyright©
New Japan Radio Co., Ltd.
Microwave Division

-Notice of Proprietary Information-

This document and its contents are proprietary to New Japan Radio Co., Ltd.
This publication and its contents may not be reproduced or distributed for any other purpose
without the written permission of New Japan Radio Co., Ltd.
Those specifications listed in this document are subject to change at any time, without notice.

New Japan Radio Co., Ltd.
Microwave Division

Title: Preliminary Specification of NJT5873 & NJT5874 series		
Reference No.:	Rev.:	Sheet:
PRD-NJT5873/74	00-05	1 / 13

Model Number

- **Numbering System**

Model No.	RF Frequency	Local Frequency	IF Frequency	Output Power	IF Connector	Power Supply	M&C Option
NJT5874NMXD	7.9 to 8.4 GHz (X-band)	6.95 GHz	950 to 1,450 MHz	60W Saturation (+47.8 dBm min.)	N-type	+36 to +60 V DC Power	Parallel I/O RS-422/485 Ethernet*note
NJT5874NMXA				AC Power			
NJT5873NMXD				40W Saturation (+46.0 dBm min.)		+36 to +60 V DC Power	
NJT5873NMXA				AC Power			

Note: Ethernet M&C interface will be installed in pre-production and production units.

New Japan Radio Co., Ltd.
Microwave Division

Title:
Preliminary Specification of NJT5873 & NJT5874 series

Reference No.:
PRD-NJT5873/74

Rev.:
00-05

Sheet:
2

1. Electrical Specifications

#	Items	Specifications
1.1.	Output RF Frequency Range	7.9 to 8.4 GHz
1.2.	Input IF Frequency Range	950 to 1,450 MHz
1.3.	Maximum IF Input Level (without damage)	+13 dBm max.
1.4.	Conversion Type	Single, fixed L.O.
1.5.	L.O. Frequency	6.95 GHz
1.6.	Frequency Sense	Positive
1.7.	Output Power @ Saturation (P _{sat})	
	<60W Model>	+47.8 dBm min. over temperature
	<40W Model>	+46.0 dBm min. over temperature
1.8.	Linear Gain	
	<60W Model>	74 dB nom., 70 dB min.
	<40W Model>	72 dB nom., 68 dB min.
1.9.	Gain Variation over Frequency @ Fixed Temperature	4 dBp-p max. over 500 MHz 2 dBp-p max. over 54 MHz
1.10.	Gain Stability over Temperature @ Fixed Frequency	4 dBp-p max. 2 dBp-p typ.
1.11.	ACPR	-30 dBc typ. @ P _{out} = P _{sat} - 3dBm
1.12.	Requirement for External Reference [Frequency] [Input Power] [Phase Noise]	10 MHz (sine-wave) -5 to +5 dBm @ Input port -120 dBc/Hz max. @ 100 Hz -130 dBc/Hz max. @ 1 kHz -140 dBc/Hz max. @ 10 kHz
1.13.	L.O. Phase Noise	-63 dBc/Hz max. @ 100 Hz -73 dBc/Hz max. @ 1 kHz -83 dBc/Hz max. @ 10 kHz -93 dBc/Hz max. @ 100 kHz -103 dBc/Hz max. @ 1 MHz
1.14.	Spurious @ P _{out} = P _{sat} - 3dBm [in band]	-60 dBc max. @ 7.9 to 8.4 GHz *note1
	[in receive and]	-20 dBm max. @ 7.25 to 7.75 GHz
	[Out-of-band]	-60 dBc max.
1.15.	Receive Band Noise Density	-85 dBm/Hz max. @ 7.25 to 7.75 GHz
1.16.	Transmit Band Noise Density	-85 dBm/Hz max. @ 7.9 to 8.4 GHz
1.17.	Input Impedance	50 ohms nom
1.18.	Input V.S.W.R.	2 : 1 max.

Note1: Except AC and AC harmonics frequency spurious.

New Japan Radio Co., Ltd.
Microwave Division

Title: Preliminary Specification of NJT5873 & NJT5874 series		
Reference No.:	Rev.:	Sheet:
PRD-NJT5873/74	00-05	3

#	Items	Specifications
1.19.	Output V.S.W.R.	1.5 : 1 max.
1.20.	Output Load V.S.W.R. [Recommendation] [Non Damage]	1.3 : 1 max. 2 : 1 max. Caution: Not endure full reflection of output load
1.21.	Power Requirement	
	1. Voltage Range < DC Power Model > < AC Power Model >	+48 VDC (+36 to +60 VDC) 100 to 240 VAC
	2. Power Consumption < 60W / DC Power Model > < 60W / AC Power Model > < 40W / DC Power Model > < 40W / AC Power Model >	- Target - 310 W max. @ Pout = +47.8 dBm 360 VA max. @ Pout = +47.8 dBm 220 W max. @ Pout = +46.0 dBm 260 VA max. @ Pout = +46.0 dBm
1.22.	Mute	Shut off the HPA in case of L.O. unlocked, no 10 MHz reference signal, or Over temperature.
1.23.	LED Indicator	GREEN: LO locked RED: LO unlocked (or no 10 MHz reference signal)
1.24.	Power Requirement	
	1. Interface	<ul style="list-style-type: none"> ● RS-485/RS-422 ● Parallel I/O ● Ethernet *note2
	2. Functions < RS-422/485 Interface > [Protocol] OpenBMIP [Monitor] Tx Output Power / Temperature / Tx Status / Alarm (Over temperature / L.O. unlock / Fan fault) [Control] Transmit On/Off / Step Attenuator < Parallel I/O Interface > [Monitor] Summary Alarm (Normal: Close) [Control] Transmit On/Off (Close: On/ Open: Off) < Ethernet Interface > [Protocol] OpenBMIP [Monitor] Tx Output Power / Temperature / Tx Status / Alarm (Over temperature / L.O. unlock / Fan fault) [Control] Transmit On/Off / Step Attenuator	

Note2: Ethernet M&C interface will be installed in pre-production and production units.

New Japan Radio Co., Ltd.
Microwave Division

Title: Preliminary Specification of NJT5873 & NJT5874 series		
Reference No.:	Rev.:	Sheet:
PRD-NJT5873/74	00-05	4

2. Mechanical Specifications

#	Items	Specifications
2.1.	Input Interface [IF / Ref. Input] [DC/AC Power Input] [M&C]	N-type female connector, 50 ohms Circular Connector: YZ-20-C04SX-03-401A Circular Connector: PT02E-14-19P (025)
2.2.	Output Interface	Waveguide, WR-112 (with Groove)
2.3.	Cooling	Forced-air-cooled
2.4.	Dimension & Housing without interface connector and screws	(W)150 x (L)215 x (H)138.5 mm [(W)5.9" x (L)8.5" x (H)5.5"]
2.5.	Weight < 60W / DC Power Model> < 60W / AC Power Model> < 40W / DC Power Model> < 40W / AC Power Model>	4.1kg [9 lbs] 4.5kg [10 lbs] 4.1kg [9 lbs] 4.5kg [10 lbs]
2.6.	Surface Finish [Protective & Conformal Coating] [Finish Painting] [Outer Color]	Trivalent Chromate Treatment or Equivalent Acrylic Paint Ivory

3. Environmental Specifications

#	Items	Specifications
3.1.	Temperature Range (ambient) [Operating] [Storage]	-40 to +60 °C -40 to +75 °C
3.2.	Humidity	0 to 100 % RH
3.3.	Altitude	15,000 feet (4,572 m)
3.4.	Vibration	5 G [49.03 m/s ²] (3 axis, 50 Hz to 2 kHz) 1 mm p-p (3 axis, 5 to 50 Hz)
3.5.	Shock	30 G [294.20 m/s ²] (3 axis)
3.6.	Waterproof / Dustproof (IP Code)	IP 67
3.7.	Regulations	EU Directive (CE Marking) RE - 2014/53/EU EMC - 2014/30/EU RoHS - 2011/65/EU + (EU)2015/863 Safety: EN62368-1, EN60950-22

New Japan Radio Co., Ltd.
Microwave Division

Title:
Preliminary Specification of NJT5873 & NJT5874 series

Reference No.:
PRD-NJT5873/74

Rev.:
00-05

Sheet:
5

#	Items	Specifications
3.8.	MIL-STD Compliance	
	1. MIL-STD-810G (Environmental)	TBD
	[Non-operating Temperature]	-30 to+60 °C, Method 501.5, Procedure I
	[Operating Temperature]	-40 to+60 °C, Method 505.6, Cycle A1, Procedure I
	[Relative Humidity]	14 %RH at +60 °C, Method 507.6 Procedure II 100 %RH from -30 to +30°C, Method 507.6 Procedure II
	[Rain and Blowing Rain]	4 inch/hour, 40 mph winds, 30 min., Method 506.6, Procedure I
	[Blowing Sand]	Sand Particles 0.01 to 1.0 mm diameter, 40 mph winds, 90 min., Method 510.6, Procedure II
	[Blowing Dust]	Dust Particles 0.0001 to 0.01 mm diameter, 15 mph winds, 90 min., Method 510.6, Procedure I
	[Salt Spray]	48 hour / 5 % concentration, Method 509.5
	[Non-operating Altitude]	40,000 feet, Method 500.6, Procedure I
	[Operating Altitude]	10,000 feet, Method 500.6, Procedure II
	[Transportation Vibration]	Method 514.7, Procedure III, Category 6
	[Transportation Shock]	Method 516.7, Procedure IV
	[Fungus]	Not resulting in evidence of fungus growth on component surface tested, Method 508.7
	2. MIL-STD-461G (EMC/EMI/ESD)	TBD
	[Radio Emissions]	RE102, Radiated Emissions, Electric Field RE103, Antenna Spurious and Harmonic Outputs
	[Conducted Emission]	CE102, Radio Frequency Potentials CE106, Conducted Emissions, Antenna Port
	[Conducted Susceptibility]	CS101, Low Frequency Susceptibility CS114, Conducted Susceptibility, Bulk Cable Injection, Curve #3 and Curve #4 CS115, Impulse Excitation CS116, Damped Sinusoidal Transients CS118, Electrostatic Discharge
3.9.	MTBF	100,000 hours as Design Condition

New Japan Radio Co., Ltd.
Microwave Division

Title:
Preliminary Specification of NJT5873 & NJT5874 series

Reference No.:
PRD-NJT5873/74

Rev.:
00-05

Sheet:
6

4. Outline Drawing

e.g. NJT5873NMXA

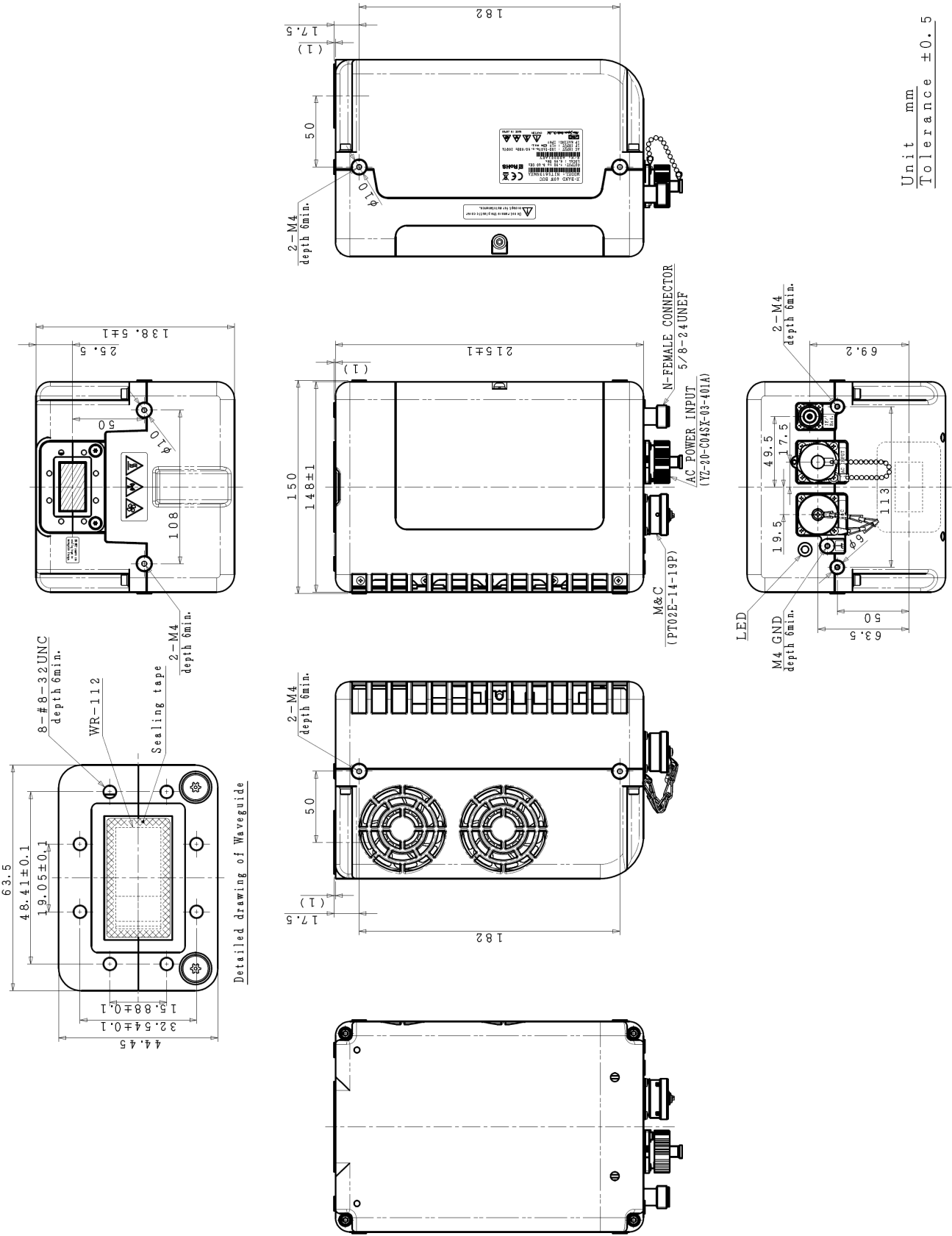

Unit mm
Tolerance ±0.5

Caution: DO NOT remove the sealing tape on the waveguide. If the sealing tape is removed, it may lose the performance of waterproof.

New Japan Radio Co., Ltd.
Microwave Division

Title: Preliminary Specification of NJT5873 & NJT5874 series		
Reference No.:	Rev.:	Sheet:
PRD-NJT5873/74	00-05	7

5. Label

5.1. Label Outline

e.g. NJT5873NMXA

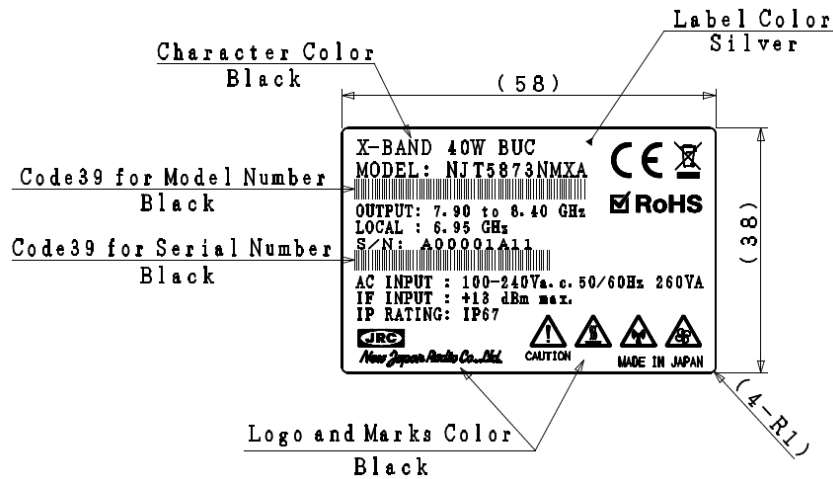

5.2. Definitions

Serial Number (OSSSSRYM) - ALPHANUMERIC (9 characters)

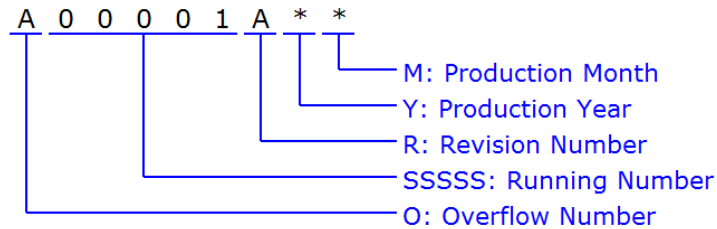

O: Overflow Number - ALPHABET (1 character)

"A" to "Z", e.g.: A99999 ⇒ B00001

SSSS: Running Number - NUMBER (5 digits)

"00001" to "99999"

R: Revision Number - ALPHABET (1 character)

"A" to "Z"

Y: Production Year - NUMBER (1 digit)

Calendar Number, e.g.: 2009:9, 2010:0, 2011:1, 2012:2

M: Production Month - ALPHANUMERIC (1 character)

"1" to "9", "X" as October, "Y" as November, "Z" as December

New Japan Radio Co., Ltd.
Microwave Division

Title: Preliminary Specification of NJT5873 & NJT5874 series		
Reference No.:	Rev.:	Sheet:
PRD-NJT5873/74	00-05	8

6. Package

6.1. Individual / Shipment Package

TBD

New Japan Radio Co., Ltd.
Microwave Division

Title:
Preliminary Specification of NJT5873 & NJT5874 series

Reference No.:
PRD-NJT5873/74

Rev.:
00-05

Sheet:
9

6.2. Enclosed Accessories

- Gasket, Qty (1), Half Type, for waveguide flange
- Wrench Key, Qty (1), #8-32UNC, Hexagon
- Screws, Qty (8), #8-32UNC×1/2, Hexagon socket head, SUS, for waveguide flange
- Spring Washers Qty(8), #8, SUS, for waveguide flange
- Screws, Qty (1), M4 x 8, cross recessed head with spring washer and flat washer, SUS, for frame ground
- Washers Qty(8), M4, SUS, for body
- Bolts, Qty (8), M4 x 10, cross recessed upset head with spring washer and flat washer, SUS, for body
- Connector, Qty (1), Mating connector: YZ-20-J04PE-03-001A (CNLinko)
- Connector, Qty (1), Mating connector: PT06E-14-19S (470) (Amphenol)

New Japan Radio Co., Ltd.
Microwave Division

Title: Preliminary Specification of NJT5873 & NJT5874 series		
Reference No.:	Rev.:	Sheet:
PRD-NJT5873/74	00-05	10

7. Instructions Manual

7.1. Descriptions

This section describes the information of Connectors and etc.

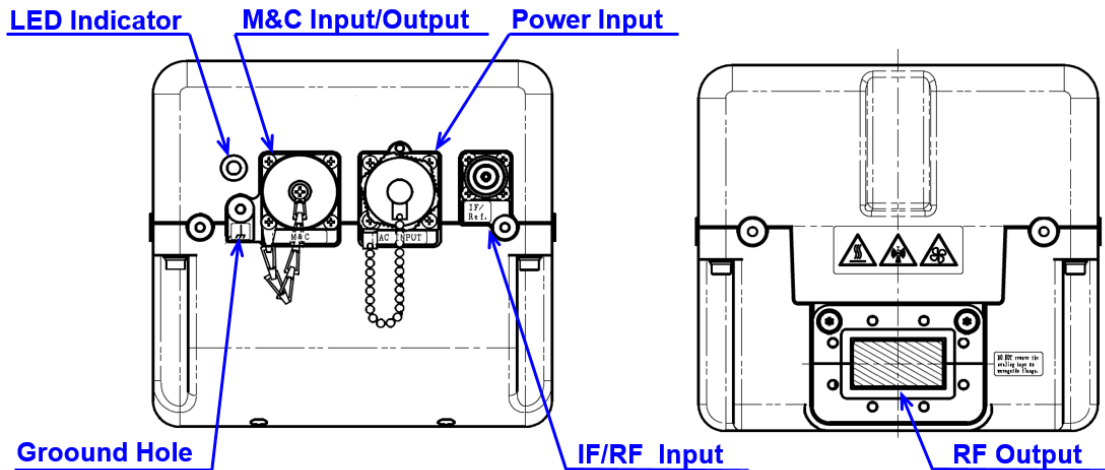

Items	Description	Purpose
LED Indicator	Red/Green Color	Local lock alarm indicator GREEN: LO locked RED: LO unlocked(or no 10 MHz reference signal) The indicator can be turned off by M&C.
M&C Input/Output	PT02E-14-19P (025) [Amphenol / 19 pins, male]	M&C signal of RS-485/RS-422 and Parallel I/O should be connected.
RF Output	Waveguide, WR-112 (with Groove)	RF signal (7.9 to 8.4 GHz) will be transmitted.
Ground Hole	M4 Screw Hole	Common chassis ground / frame ground.
Power Input	YZ-20-C04SX-03-401A (CNLinko / 4pins, male)	DC power (+48V nominal) or AC power (100 to 240 V) should be input, which are dependent on power supply type.
IF/Ref Input	N-type Female Connector	IF signal (950 to 1,450 MHz) and 10MHz reference signal should be input.

7.2. Connector Pin Assignment

a) Power Input

Unit Connector: YZ-20-C04SX-03-401A [CNLinko / 4pins, receptacle, male]

Mating Connector: YZ-20-J04PE-03-001 [CNLinko / 4pins plug, female]

* Mating connector is enclosed in the shipping package

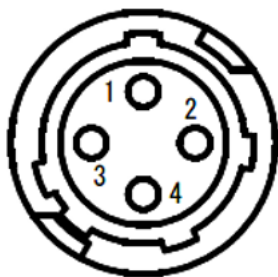

AC Power Model

Pin No.	Item	Description
1	AC Power - L (Live)	100 to 240V, AC Voltage
2	AC Power - N (Neutral)	100 to 240V, AC Voltage
3	N.C.	
4	Frame Ground	GND

DC Power Model

1	N.C.	
2	DC Power -Input(-)	Prime : +48V (Range : +36V to+60V)
3	DC Power -Input(+)	Prime : +48V (Range : +36V to+60V)
4	Frame Ground	GND

New Japan Radio Co., Ltd.
Microwave Division

Title:
Preliminary Specification of NJT5873 & NJT5874 series

Reference No.:
PRD-NJT5873/74

Rev.:
00-05

Sheet:
11

b) M&C Input/Output

Unit Connector: PT02E-14-19S(025) [Amphenol / 19 pins, receptacle, male]

Mating Connector: PT06E-14-19P(470) [Amphenol / 19 pins, female]

* Mating connector is enclosed in the shipping package

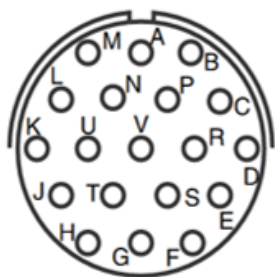

Pin No.	Item	Description
A	N.C.	
B	N.C.	
C	Rx- (100BASE-T)	Ethernet
D	Summary Alarm (-)	Parallel I/O , Pair to Pin No.R
E	Rx- (RS422/RS485)	Full Duplex Operation of RS422/485
F	GND	
G	N.C.	
H	N.C.	
J	Tx+ (RS422/RS485)	Full Duplex Operation of RS422/485
K	Transmit On/Off Control (+)	Parallel I/O , Pair to Pin No.U Close: On / Open: Off *note Schematic is referred to fig.7.2.1
L	Tx+ (100BASE-T)	Ethernet
M	N.C.	
N	Tx- (100BASE-T)	Ethernet
p	Rx+ (100BASE-T)	Ethernet
R	Summary Alarm (+)	Parallel I/O , Pair to Pin No.D Normal: Close / Abnormal: Open Schematic is referred to fig.7.2.1
S	Rx+ (RS422/RS485)	Full Duplex Operation of RS422/485
T	Tx- (RS422/RS485)	Full Duplex Operation of RS422/485
U	Transmit On/Off Control (-)	Parallel I/O , Pair to Pin No.K
V	N.C.	

Note: Transmit On/Off Control can be set with "enable" or "disable".

Default is "disable", which is "Transmit On" regardless close / open setting.

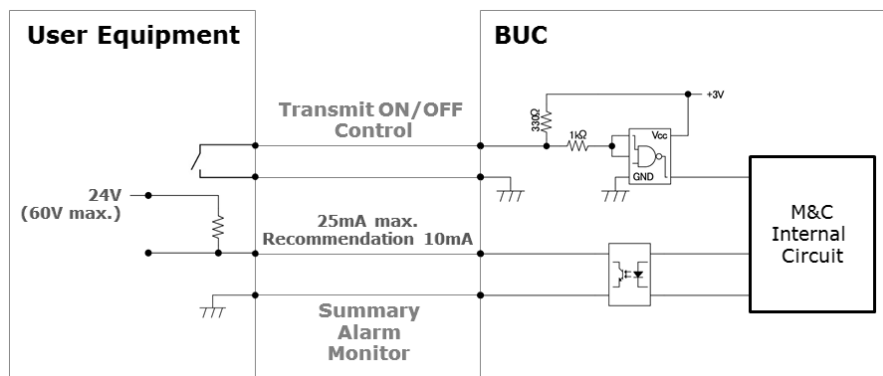

Fig. 7.2.1 Schematic of M&C Parallel I/O



Caution

1. While New Japan Radio., Ltd.(NJR) continually strives to improve the quality and reliability of any products, failures would occur in microwave products over time. For this reason, it is important that customers fulfill their responsibilities to ensure designed-in safety – including failsafe functions, redundancy, and measures to prevent malfunctions and the spread of fire – in order to avoid injuries, accidents, or social repercussions resulting from the failure of any product related to satellite communications on this document (hereinafter, “the product”). Customers must pay careful attention to ensuring the safety of their equipment.
2. The product is designed and tested to function in accordance with its specifications. Do not use under conditions that deviate from the product specifications included in the specifications. NJR assumes no responsibility and shall not be liable for any injuries, accidents, or social repercussions resulting from the product being in a poor or damaged state because it was used under conditions that depart from the specifications.
3. The product is covered by a warranty for one year following delivery unless otherwise stipulated in the contract or delivery conditions. In the event of a failure for which NJR are responsible occurring during the warranty period, NJR undertake to repair or replace the product free of charge. Note, however, that the warranty does not cover failures such as those listed here (see bullets below), even if they occur within the warranty period. In addition, in the case of a product being repaired or replaced by us, the starting date for the warranty period is still the original delivery date of the product.
 - Failure due to the product being used in conditions other than those stipulated in the data sheet, specification sheet, etc.
 - Failure due to modifications or repairs carried out by some entity other than our company
 - Failure determined to be the result of unsuitable maintenance or replacement of a consumable item that requires due maintenance
 - Failure due to circumstances that were unforeseeable given the scientific/technological standards at the time of shipment
 - Other failures due to external factors such as fire, earthquake, flood and power supply anomalies for which NJR are not responsible

In addition, the product warranty is limited to the provision of repair services or replacement at no cost. It does not cover secondary damage (to equipment, business opportunities, profits, etc.) or any other damage that may have resulted from failure of the product.
4. The product must be handled appropriately to ensure its continued reliability. Since it can be damaged by the intrusion of water, dust, oil, chemicals, etc., it must be given appropriate protection. Even in the case of a product with an airtight construction, avoid using it in an environment that exceeds the stated levels of waterproofing/dustproofing. Also, be sure to use connectors and waveguides properly.

If replacement parts such as fans are included, proper maintenance is necessary. To maintain product performance and functionality, it is necessary to conduct inspections and maintenance at appropriate intervals and exchange replacement parts when necessary. Improper inspections or maintenance may result in failure.

In addition, the warranty does not cover the use of the product in areas where salt damage can be expected or where there is a substantial presence of corrosive gases such as Cl₂, H₂S, SO₂, and NO₂. If the product is to be used in such areas, at the time of installation you must take appropriate steps to protect the product.
5. If the product is to be used with equipment/systems that must meet special quality and reliability standards (aerospace equipment, medical equipment, power generation control equipment, automotive/railway transportation equipment, safety equipment, disaster prevention and security equipment, etc.), please consult with our sales staff in advance.
6. This product contains gallium arsenide (GaAs), classified as a harmful substance. To avoid danger, do not incinerate, crush, or chemically treat the product in such a way that gases or dust are released. When disposing of the product, comply with all applicable laws and regulations and do not treat it as general industrial waste or household waste.
7. When exporting a product or technology, observe export laws and regulations such as those governing foreign exchange and foreign trade, and obtain any necessary licenses for export, service transactions, etc. NJR request that you do not use our products or the technical data published on this document for developing weapons of mass destruction or for any other military purposes or applications.
8. The product specifications on this document are subject to change without notice. If you are considering using a product, delivery specifications must first be settled.

<p>New Japan Radio Co., Ltd. Microwave Division</p>	<p>Title: Preliminary Specification of NJT5873 & NJT5874 series</p>		
	<p>Reference No.: PRD-NJT5873/74</p>	<p>Rev.: 00-05</p>	<p>Sheet: 13</p>